

# Product Catalogue - Motorhome, Caravan & Van Accessories

2024









# ABOUT US

Founded in 2016, **ARANA** has been striving to become a professional supplier of air conditioner, refrigerator, kitchens and sanitary in China Recreational Vehicle market. We devote ourselves to making RV life more convenient and comfortable with reliable quality and professional service, creating a different RV experience and adding vigor and power to the development of China RV market.

Adhering to the brand concept "Make A Difference", **ARANA** is rooted in China market, provides customer and market different choices and makes each journey more pleasant and memorable by concentrating on researching customers needs and creating high quality products elaborately.

# TABLE OF CONTENT

---

RV AIR CONDITIONER / ARANA	06
RV COMPRESSOR REFRIGERATOR / ARANA	16
RV INSTANTANEOUS GAS WATER HEATER / ARANA	28
RV MULTIFUNCTION SWITCHES & SOCKETS / WONYEX	34
RV POWERED CEILING FANS / RVGUARDIAN	42
RV BUILT-IN SOCKETS / RVGUARDIAN	54

---



# ARANA RV AIR CONDITIONER





# ARANA RV AIR CONDITIONER

ARANA RV air conditioners currently have three series, such as KAC series, FRESCO series and CARBONADO series.

In 2018, ARANA launched the first generation of KAC series roof top air conditioner, which have independent operation double fans, slim body and four way air distribution panel, etc and developed the KAC 25 model for the European market. In June 2023, the new generation of KAC series are launched to the market, with more streamlined body appearance, the flatter body height, the newly designed air diffuser and LED lighting strips, making the KAC series more fashionable and refined.

FRESCO series inverter air conditioners are the third generation of RV air conditioner that ARANA has developed over three years, adopting the latest DC inverter technology and dual-rotor compressor, running more smoothly with less vibration and lower noise. FRESCO series air conditioners have become the best selling products in the Middle East market after several years operation in the hot and harsh environment.

By analyzing and researching the existing under bench air conditioners on the market, ARANA developed and launched the inverter under bench air conditioner CARBONADO D2600, equipped with DC inverter compressor, using environmental R32 refrigerant, and the weight is only 18.5kgs, very small and light. CARBONADO D2600 is very suitable for small and medium sized RVs and caravans, providing an additional choice for customers of under bench air conditioners.



---

CARBONADO D2600	10
KAC 33/36	12
FRESCO 40	14

---

# CARBONADO D2600



## RV UNDER BENCH INVERTER AIR CONDITIONER



- Equipped with new DC inverter compressor, running with less vibration, low noise, efficient and quiet.
- Small and light, can be installed under the bunk or bench, without taking up extra space.
- Enjoy cool and warm strongly and rapidly  
Optimized duct structure for smooth air blowing. High cooling air flow with low noise.
- With 3 air outlets, can be located anywhere to meet the different requirements of cooling or heating in different areas, to improve the comfort of RV life.

<b>Model</b>	<b>CARBONADO D2600</b>
cooling capacity	2600W
Heating capacity	2750W
Rated input voltage	220-240V AC/50Hz
Power consumption in cooling mode	4.4A
Power consumption in heating mode	6.4A
Operation temperature	-5°C~ 48°C
Refrigerant	R32
Refrigerant quantity	450g
Protection class	IPX5
Max length (recommended with insulated walls)	≤ 6m
Airflow	380m <sup>3</sup> /h
Dimensions L x W x H	630 x 400 x 290mm
Weight	20 kg



# KAC 33/36



## RV ROOF TOP AIR CONDITIONER



- Re-optimized design, comprehensive upgrade, powerful performance, more quiet and comfortable, more efficient and energy-saving
- Upgrade the new fixed speed/inverter compressor, more stable and quiet
- New Turbo and Sleep modes added, to meet the needs of different application environments
- Brand new control panel, built-in LED light strips, operated by remote controller, with the perfect blend of refined look and comfort

Model	KAC33	KAC36
Type	Fixed speed	Inverter
Control type	Remote control	Remote control
Compressor cooling capacity	3000W	3300W
Input power cooling	1050W	1240W
Heating capacity	2400W	2500W
Input power electric heater	780W	1050W
Rated input voltage	220V ~ 240V 50Hz	220V ~ 240V 50Hz
Power consumption in cooling mode	4.8A	5.6A
Power consumption in heating mode	3.6A	4.8A
Starting current compressor	14A	7A(Max.)
Refrigerant	R410a	R410a
Refrigerant quantity	560g	560g
Airflow high speed	550m <sup>3</sup> /h	550m <sup>3</sup> /h
Dimensions L x W x H	920 x 765 x 223mm	920 x 765 x 223mm
Weight	33.7kg	39kg

# FRESCO 40

## RV INVERTER AIR CONDITIONER



- DC inverter compressor silent and efficient  
Dual-rotor compressor with less vibration and low noise quietly accompanies your sleep.
- Fresh air system to offer clean air  
5% air exchange rate to ensure fresh air circulation for more care for the family.
- Enjoy cool and warm strongly and rapidly  
Optimized duct structure for smooth air blowing. High cooling air flow with low noise.
- High performance and outstanding quality  
High operating temperature range of  $-5^{\circ}\text{C}$  ~  $52^{\circ}\text{C}$  to guarantee a carefree journey.
- Simplicity design created with ingenuity  
ASA housing, excellent weather resistance sound absorption and lightweight.  
Streamlined low profile design 223mm on roof top.



<b>Model</b>	<b>FRESCO 40</b>
Compressor cooling capacity	3600W
Input power cooling	1398W
Heating capacity	3300W
Input power electric heater	1473W
Rated input voltage	220V AC / 50Hz
Power consumption in cooling mode	6.3A
Power consumption in heating mode	6.7A
Applicable temperature	-5°C~ 52°C
Applicable maximum vehicle length	≤ 7.5m
Refrigerant	R410a
Blower	3 levels/1 automatic
Dimensions L x W x H	1075 x 720 x 223mm
Weight	38kg

# ARANA RV COMPRESSOR REFRIGERATOR









# ARANA RV COMPRESSOR REFRIGERATOR

Adhering to Italian aesthetic concept, ARANA BFC series compressor refrigerator is designed with simplicity and perfect combination of compactness and practicability. Its reliable performance achieved by innovative technology lets you enjoy quality life at any time.

FRESCO compressor fridge, surmounting the traditional design, streamlined slim cabinet with large storing volume. Making full use of the extending upward space, practicality and aesthetic feeling are mixed together well, re-defining the new concept of RV layout.

RV specialized compressor fridge of high quality, with 12~24V DC power supply. Strong "heart" which bears of excellent performance, traveling life is being more cozy and relaxing.

---

BFC 96	20
BFC 135	22
BFC 157	24
BFC 185	24

# BFC 96

## RV COMPRESSOR REFRIGERATOR



- Small size large capacity  
20L freezer compartment to store fresh food for the whole family easily enjoy camping and barbecue.
- EXTENSIVE VOLTAGE AC/DC\*  
Operates at 12/24V DC and 110/240V AC. Automatically switches to AC mains to extend battery life when connecting AC power supply.
- Energy efficient ultra-silent operation  
QUICK COOL mode, strong cooling to meet fast low temperature demands.
- RELIABLE OPERATION TO HANDLE EXTREME VIBRATIONS  
Aseismic and anti-shake. Reliable operation even when tilted up to 30 degrees.

\*AC function is optional, not standard.



<b>Model</b>	<b>BFC 96</b>
Gross volume	96L
Freezer storage volume	20L
Connection voltage	12V/24V
Power rating Day/Night mode	0.46/0.36KWH/24H
Rated current	4.5A/2.5A
Refrigerating temperature range	0° C to 10° C
Freezer temperature range	-10° C to -18° C
Climatic class	N (4)
Noise emission Day/Night mode	33/28DB(A)
Refrigerant	R134A
Refrigerant quantity	45G
Dimension	419×472×1098MM
Weight	23KG
Foaming agent	C5H10
Inspection/certification	CE

# BFC 135

## RV COMPRESSOR REFRIGERATOR



- 135L streamlined slim design  
Being smaller width, perfect space saver inside RV in horizontal
- 51L extra-large freezing space  
With storage boxes on the door of freezer compartment meeting different delicacy requirements in trip.
- Separate temperature control of refrigerator and freezer compartments  
Touching screen for precise temperature control, different foods are kept well with nutrition and delicacy.
- Lower consumption and noise excellent cooling performance  
Operating with 12/24V DC to lower power bills and protect the environment.  
With specialized RV compressor, anti-shocking and shaking even driving on rough roads.  
Keeping efficient working even with inclination of 30° .
- Personalized specifications  
Replaceable door panels creating colorful and personalized living space.  
Reversible doors for flexible inside designs and layouts.
- Thoughtful details  
Innovative handle design with locking and airing functions.  
Replaceable sealing strip, easy to clean keeping away from bacteria.  
Built-in LED lamps in both refrigerator and freezer compartments to deliver clear and power-saving illumination.

<b>Model</b>	<b>BFC 135</b>	
Gross volume	135L	
Freezer storage volume	51L	
Rated power	80W	
Rated current	7A/12V	3.5A/24V
Min. starting voltage	10.9V/12V	22.7V/24V
Min. working voltage	10.1V/12V	22.3V/24V
Power consumption under 32° C ambient temperature	0.55KW/24H	
Refrigerating temperature range	0° C to 10° C	
Freezer temperature range	-5° C to -18° C	
Climatic class	T	
Dimensions L x W x H	419×580×1299MM	
Max. tilt angle	30°	
Weight	Net weight: 36Kg Gross weight: 42Kg	
Dimming time of display	Without operation for 5 minutes	
Pressing time of unlock key	3S	
Pressing time of power key	3S	

# BFC 157

## RV COMPRESSOR REFRIGERATOR



- 157L streamlined slim design  
Being smaller width, perfect space saver inside RV in horizontal
- 73L extra-large freezing space  
With storage boxes on the door of freezer compartment meeting different delicacy requirements in trip.
- Separate temperature control of refrigerator and freezer compartments  
Touching screen for precise temperature control, different foods are kept well with nutrition and delicacy.
- Lower consumption and noise excellent cooling performance  
Operating with 12/24V DC to lower power bills and protect the environment.  
With specialized RV compressor, anti-shocking and shaking even driving on rough roads.  
Keeping efficient working even with inclination of 30° .
- Personalized specifications  
Replaceable door panels creating colorful and personalized living space.  
Reversible doors for flexible inside designs and layouts.
- Thoughtful details  
Innovative handle design with locking and airing functions.  
Replaceable sealing strip, easy to clean keeping away from bacteria.  
Built-in LED lamps in both refrigerator and freezer compartments to deliver clear and power-saving illumination.



<b>Model</b>	<b>BFC 157</b>	
Gross volume	157L	
Freezer storage volume	73L	
Rated power	80W	
Rated current	7A/12V	3.5A/24V
Min. starting voltage	10.9V/12V	22.7V/24V
Min. working voltage	10.1V/12V	22.3V/24V
Power consumption under 32° C ambient temperature	0.60KW/24H	
Refrigerating temperature range	0° C to 10° C	
Freezer temperature range	-5° C to -18° C	
Climatic class	T	
Dimensions L x W x H	419×580×1499MM	
Max. tilt angle	30°	
Weight	Net weight:40Kg Gross weight:47Kg	
Dimming time of display	Without operation for 5 minutes	
Pressing time of unlock key	3S	
Pressing time of power key	3S	

# BFC 185

## RV COMPRESSOR REFRIGERATOR



- 185L streamlined slim design  
Being smaller width, perfect space saver inside RV in horizontal
- 73L extra-large freezing space  
With storage boxes on the door of freezer compartment meeting different delicacy requirements in trip.
- Separate temperature control of refrigerator and freezer compartments  
Touching screen for precise temperature control, different foods are kept well with nutrition and delicacy.
- Lower consumption and noise excellent cooling performance  
Operating with 12/24V DC to lower power bills and protect the environment.  
With specialized RV compressor, anti-shocking and shaking even driving on rough roads.  
Keeping efficient working even with inclination of 30° .
- Personalized specifications  
Replaceable door panels creating colorful and personalized living space.  
Reversible doors for flexible inside designs and layouts.
- Thoughtful details  
Innovative handle design with locking and airing functions.  
Replaceable sealing strip, easy to clean keeping away from bacteria.  
Built-in LED lamps in both refrigerator and freezer compartments to deliver clear and power-saving illumination.

<b>Model</b>	<b>BFC 185</b>	
Gross volume	185L	
Freezer storage volume	73L	
Rated power	80W	
Rated current	6.5A/12V	3.25A/24V
Min. starting voltage	10.9V/12V	22.7V/24V
Min. working voltage	10V/12V	21.3V/24V
Power consumption under 32° C ambient temperature	0.65KW/24H	
Refrigerating temperature range	0° C to 10° C	
Freezer temperature range	-5° C to -18° C	
Climatic class	T	
Dimensions L x W x H	419×580×1700MM	
Max. tilt angle	30°	
Weight	Net weight:45Kg Gross weight:53Kg	
Dimming time of display	Without operation for 5 minutes	
Pressing time of unlock key	3S	
Pressing time of power key	3S	

# ARANA INSTANTANEOUS GAS WATER HEAT



ER





# ARANA INSTANTANEOUS GAS WATER HEATER

ARANA water heater is designed specially for RV hot water system, and the whole operating process is controlled by its microcomputer intelligent control system, to ensure continuous supply of constant temperature water.

The multi-safety devices such as overheating, anti-freezing, flame out, dry-burning, water overpressure protection, are monitored by the microcomputer intelligent control system so that the heater will be shut down immediately in case of any malfunction to ensure the safety.



# RH09G



## INSTANTANEOUS GAS WATER HEATER



- New smart technology, no preheating needed, always enjoy a steady hot water at any time.
- Automatic pulse ignition, segmented burners, precise temperature control, improve bathing comfort, and meet water needs in different seasons.
- Strong wind resistance, the design of the anti wind-back device could prevent cold air from entering the heat exchanger, and prevent the water tank from freezing and cracking during low temperature operation;
- Frost protection function: when the temperature of the water pipe in the water heater is lower than  $6\pm 1\text{ }^{\circ}\text{C}$  ( $43\text{ }^{\circ}\text{F}\pm 2\text{ }^{\circ}\text{F}$ ), the machine will start ignition and run with a certain load and automatically shut down after running for 5 seconds; When the water temperature reaches  $32\pm 1\text{ }^{\circ}\text{C}$  ( $90\text{ }^{\circ}\text{F}\pm 2\text{ }^{\circ}\text{F}$ ) in 2 seconds, it will shut down automatically.
- Fault auto-diagnosis and fault code display function.
- ETL certification.
- SAI certification.
- Water Mark certification.
- SAA certification.

Model	RH09G
Gas	Universal LPG
Total nominal gas consumption	17.5KW
Number of injector	5
Injector size	1.1MM
Max. working water pressure	0.4MPA
Min. working water pressure	0.1MPA
Nominal test point pressure	2.8KPA
Nominal manifold pressure	1.92KPA
Weight	13.5KG
Electrical power	12VDC, 3AMP
Water heating capacity (temp rise 25K)	9L/MIN
Maximum water temp	51°C
Heat output	15.2KW





# WONYEX RV MULTIFUNCTIONAL SWITCHES & SOCKETS



**ON**



# **WONYEX RV MULTIFUNCTION SWITCHES & SOCKETS**

SWITCH/SPST/ON/OFF	38
SWITCH/SPDT/ON/OFF	38
SWITCH/DPST/ON/OFF	39
MULTIPLE SOCKET WITH EARTHING CONTACT	39
USB CHARGING SOCKET	40
PUSH BUTTON	40
WATERPROOF HINGED COVER	41
2/3 MODULE FRAME	41





## Switch/SPST/on/off

3C/CE certifications

Model: CK-01

Rated Current: 16AX

Voltage: 250V AC



White



Black



Silver

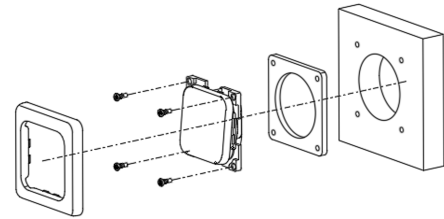
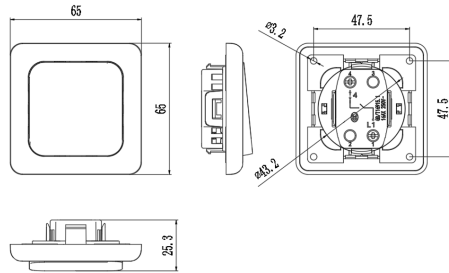

## Switch/SPDT/on/off

3C/CE certifications

Model: CK-02

Rated Current: 16AX

Voltage: 250V AC



White



Black



Silver

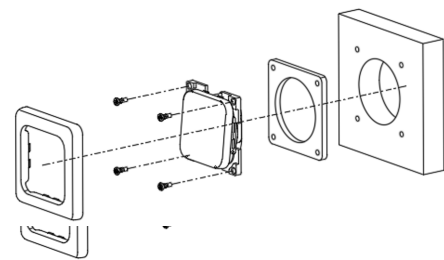
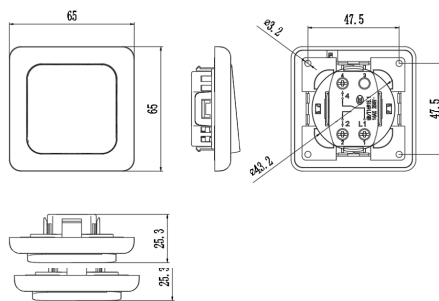



## Switch/DPST/on/off

3C/CE certifications

**Model: CK-03**  
 Rated Current: 16AX  
 Voltage: 250V AC



White



Black



Silver

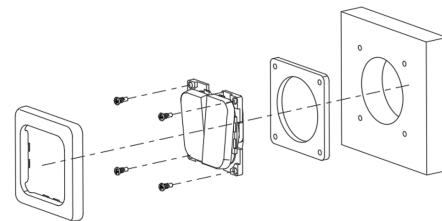
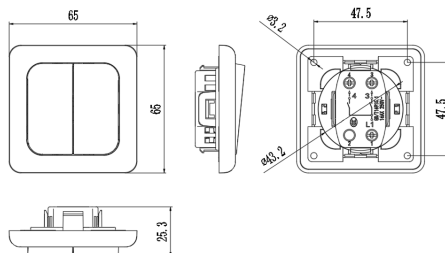

## Multiple socket with earthing contact

3C/CE certifications

**Model: CK-04**  
 Rated Current: 10A  
 Voltage: 250V AC



White



Black



Silver

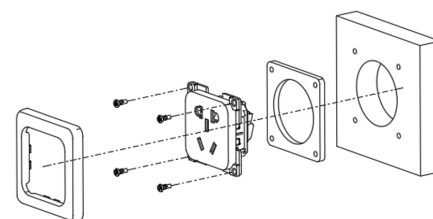
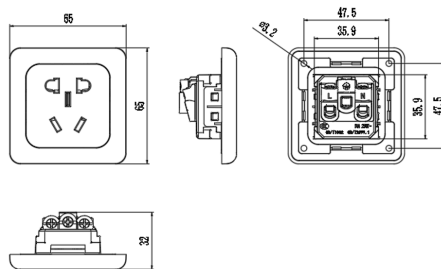



## USB charging socket

3C/CE certifications

Model: CK-05

Input Voltage: DC12V

Output Voltage: DC5V Output Current: DC3A



White



Black



Silver

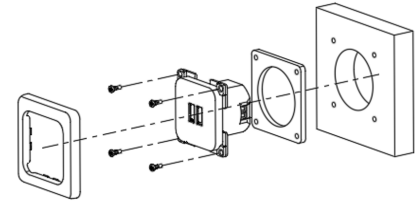
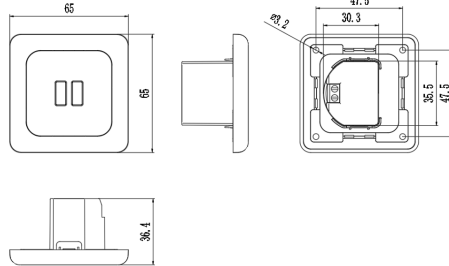

## Push button

3C/CE certifications

Model: CK-06/CK-07

Rated Current: 16AX

Voltage: 250V AC



White



Black



Silver

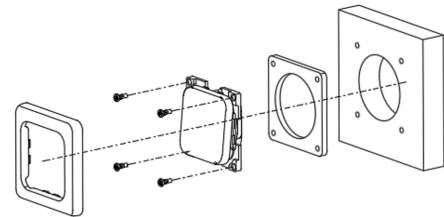
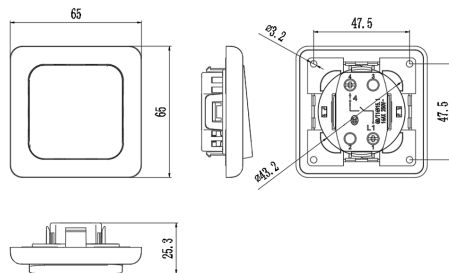



## Waterproof hinged cover

Model: CK-W  
Protection Class: IP44



White



Black

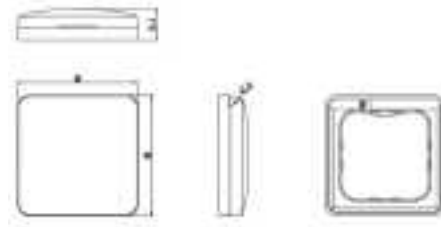

## 2/3 module frame

Model: CK-F2/CK-F3  
Dimensions: 120×65mm  
Dimensions: 175×65mm



White



Black



Silver

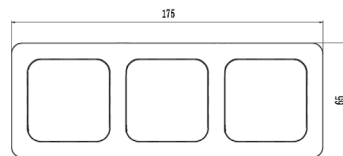
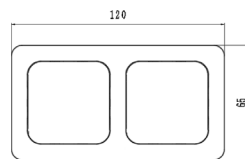

White



Black



Silver

# RV GUARDIAN RV POWERED CEILING FANS







# RV GUARDIAN

# RV POWERED CEILING FANS

Electrical model: electrical lid lift and closing, manual mode and infrared remote control available.

Manual model: improved worm and wheel structure to narrow the running gap and make lifting smoother. Knob locking function available to avoid wind leaking and noise whilst driving. Upgrade to electric model as optional (KIT upgrading).

Intaking and exhausting function, bringing in fresh air and removing the hot musty air and odors. The unique plasma air purification function to make the inside air fresh.

Temperature sensor, operating automatically according to the setting temperature.

Rain sensor, closing in rainy days. Unique wind sensor function to make lid closed automatically in high winds or whilst driving at high speed to avoid damage.

The unique closed design of motor support rod, increasing the structural strength, decreasing the structural damage, it can be used under the condition of low driving speed, and all the materials are with good quality of weather resistance.

485 interface (connecting with the vehicle central control system to achieve unified control).

Easy to remove interior insect screen, no tools required.

Added indoor shade and LED lighting panel, to solve shading problems and add lighting function practicably (a separate product, applicable for all fans in the market).

Gas and carbon monoxide alarm function available, fans automatically run to discharge harmful gas from vehicle or reduce the density of harmful gas quickly to maximize air safety inside vehicle when induction service alarming.

All-weather function package to achieve using in all conditions (moving, raining), fanless ventilation and air circulation to lower temperature (KIT upgrading).

---

RV CEILING FAN T2000	46
RV CEILING FAN T3000	48
RV CEILING FAN T5000	50
SUNSHADE LED PANEL	52

---

# T2000

## RV CEILING FAN



- 8-speed fan
- Manual lid lift/closing
- Touch button
- Intaking & exhausting
- Ceiling fan
- Removable insect screen
- Silent operation with high air flow

<b>Model</b>	<b>T2000</b>
Lid Opening	Manually
Fan Speed	8
Touch Button	✓
Thermostat	
Intaking & Exhausting	✓
Wireless Control	
Rain Sensor	
Ceiling Fan	✓
Air Purification	
Integrated Control	
Remote Control	
Automatic Closing when Driving	
Wind Discharging Against Smog Alarming	
Lid Color	Smoke
Sunshade/LED light	Optional
Opening size	360X360
Installation thickness	48MM~134MM

# T3000

## RV CEILING FAN



- 10-speed fan
- Manual lift/closing lid
- Touch button
- Intaking & Exhausting
- Remote control with fixing bracket on the wall
- Thermostat to control room temperature; Rain sensor, closing automatically when it rains.
- Ceiling fan
- Removable insect screen
- Silent operation with high air flow



<b>Model</b>	<b>T3000</b>
Lid Opening	Electrical
Fan Speed	10
Touch Button	✓
Thermostat	✓
Intaking & Exhausting	✓
Wireless Control	✓
Rain Sensor	✓
Ceiling Fan	✓
Air Purification	Optional
Integrated Control	Optional
Remote Control	Optional
Automatic Closing when Driving	Optional
Wind Discharging Against Smog Alarming	Optional
Lid Color	Smoke
Sunshade/LED light	Optional
Opening size	360X360
Installation thickness	48MM~134MM

# T5000

## RV CEILING FAN



- 10-speed fan
- Electrical lift/closing lid
- Touch button
- Intaking & Exhausting
- Remote control with fixing bracket on the wall
- Thermostat to control room temperature; Rain sensor, closing automatically when it rains
- Vehicle central control
- Internet remote control
- Air protection (wind discharging against smog alarming)
- Ceiling fan
- Removable insect screen
- Silent operation with high air flow

<b>Model</b>	<b>T5000</b>
Lid Opening	Electrical
Fan Speed	10
Touch Button	✓
Thermostat	✓
Intaking & Exhausting	✓
Wireless Control	✓
Rain Sensor	✓
Ceiling Fan	✓
Air Purification	Optional
Integrated Control	✓
Remote Control	✓
Automatic Closing when Driving	✓
Wind Discharging Against Smog Alarming	Optional
Lid Color	Smoke
Sunshade/LED light	Optional
Opening size	360X360
Installation thickness	48MM~134MM

# SUNSHADE LED PANEL

## ALL IN ONE VENTILATION SYSTEM



- Remote control/manual control
- Light adjust by two levels
- Sliding sunshade
- Suitable for all 360\*360 opening ceiling fans
- The window knob should not be higher than the interior to ensure the normal use of shading function

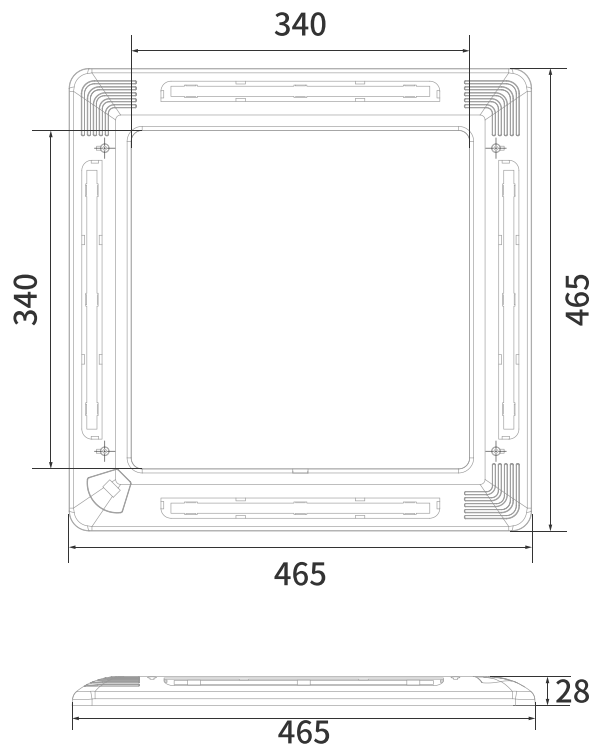

A photograph of an RV interior showing a white built-in electrical socket on a wall. To the left, a grey door handle is visible. The text 'RV GUARDIAN RV BUILT-IN SOCKETS' is overlaid in large, bold, yellow letters.

# RV GUARDIAN RV BUILT-IN SOCKETS







# **RVGUARDIAN RV BUILT-IN SOCKETS**

---

RV BUILT-IN GRAVITY WATER INLET	58
RV BUILT-IN POWER INLET	58
RV BUILT-IN EXTERIOR SHOWER KIT	59
RV BUILT-IN MIXER SHOWER KIT	59
RV BUILT-IN POWER OUTLET	60
RV BUILT-IN POWER OUTLET	60
RV GAS OUTLET	61
RV EV POWER CHARGING SOCKET	61
RV BUILT-IN POWER OUTLET	62
RV BUILT-IN POWER OUTLET	62
RV BUILT-IN CITY WATER INLET	63
RV MULTI PURPOSE INLET	63

---



## RV BUILT-IN GRAVITY WATER INLET

### KDAS-Z01

Food Grade

- High performance engineering plastic housing, with good corrosion resistance and food grade.
- Dimensions (W x H x D): 115x136x15mm.
- Color: White, black.
- Installation aperture:  $\varnothing$  96mm.
- Diameter of interior connection 1-1/2 inch.
- 4 x ST4.2\*25 countersunk head self tapping screws for front installation, screw aperture 4.5mm.  
Sides spacing: 92mm(horizontal), 92mm(vertically), 130mm (diagonal line).



## RV BUILT-IN POWER INLET

### KDAD-16A

3C/CE certifications

- High performance engineering plastic housing, with good corrosion resistance.
- Applicable to 230V/16A.
- Dimensions (W x H x D): 115x136x15mm.
- Color: White, black.
- Installation aperture:  $\varnothing$  96mm.
- Protection Class: IP44.
- 4 x ST4.2\*25 countersunk head self tapping screws for front installation, screw aperture 4.5mm.  
Sides spacing: 92mm (horizontal), 92mm (vertically), 130mm(diagonal line).



## RV BUILT-IN EXTERIOR SHOWER KIT

### KDAS-L01

3C/CE certifications

- High performance engineering plastic housing, with good corrosion resistance.
- Dimensions (W x H x D): 115x136x15mm.
- Color: White, black.
- Installation aperture: Ø 96mm.
- Quick connect shower head with 1.5m hose.
- Food grade tap as optional, interchangeable with shower kit.
- 4 x ST4.2\*25 countersunk head self tapping screws for front installation, screw aperture 4.5mm.  
Sides spacing: 92mm (horizontal), 92mm (vertically), 130mm(diagonal line).



## RV BUILT-IN MIXER SHOWER KIT

### KDAS-L02

3C/CE certifications

- High performance engineering plastic housing, with good corrosion resistance.
- Dimensions (W x H x D): 115x136x15mm.
- Color: White, black.
- Opening size for installation: Rectangle opening 90x105mm.
- Quick connect shower head with 1.5m hose.
- Hot and cold water mixture, pluggable control lever, rotating to adjust the water temperature.
- 4 x ST4.2\*25 countersunk head self tapping screws for front installation, screw aperture 4.5mm.  
Sides spacing: 92mm (horizontal), 92mm (vertically), 130mm(diagonal line).



## RV BUILT-IN POWER OUTLET

### KDAQ-10A

3C/CE certifications

- High performance engineering plastic housing, with good corrosion resistance.
- Applicable to 110V~250V/10A 12V~24V/120W~250W.
- Dimensions (W x H x D): 115x136x15mm.
- Color: White, black.
- Opening size for installation: Rectangle opening 90x105mm.
- Protection Class: IP44.
- 4 x ST4.2\*25 countersunk head self tapping screws for front installation, screw aperture 4.5mm.  
Sides spacing: 92mm(horizontal), 92mm(vertically), 130mm (diagonal line).



## RV BUILT-IN POWER OUTLET

### KDAQ-10B

3C/CE certifications

- High performance engineering plastic housing, with good corrosion resistance.
- Applicable to 110V~250V/10A.
- Dimensions (W x H x D): 115x136x15mm.
- Color: White, black.
- Opening size for installation: Rectangle opening 90x105mm.
- Protection Class: IP44.
- 4 x ST4.2\*25 countersunk head self tapping screws for front installation, screw aperture 4.5mm.  
Sides spacing: 92mm(horizontal), 92mm(vertically), 130mm (diagonal line).





## RV GAS OUTLET

### KDAR-Q01

3C/CE certifications

- High performance engineering plastic housing, with good corrosion resistance.
- Applicable to RV gas outlet.
- Dimensions (W x H x D): 115x136x15mm.
- Color: White, black.
- Opening size for installation: Rectangle opening 90x105mm.
- Protection Class: IP44.
- 4 x ST4.2\*25 countersunk head self tapping screws for front installation, screw aperture 4.5mm.  
Sides spacing: 92mm(horizontal), 92mm(vertically), 130mm (diagonal line).



## RV EV POWER CHARGING SOCKET

### KDAX-M32A

3C/CE certifications

- High performance engineering plastic housing, with good corrosion resistance.
- Applicable to 230V/32A.
- Dimensions (W x H x D): 115x136x15mm.
- Color: White, black.
- Opening size for installation: Rectangle opening 90x105mm.
- Protection Class: IP44.
- 4 x ST4.2\*25 countersunk head self tapping screws for front installation, screw aperture 4.5mm.  
Sides spacing: 92mm(horizontal), 92mm(vertically), 130mm (diagonal line).



## RV BUILT-IN POWER OUTLET

### KDAQ-16A

3C/CE certifications

- High performance engineering plastic housing, with good corrosion resistance.
- Applicable to 250V/16A, 5V/2100mA.
- Dimensions (W x H x D): 115x136x15mm.
- Color: White, black.
- Opening size for installation: Rectangle opening 90x105mm.
- Protection Class: IP44.
- 4 x ST4.2\*25 countersunk head self tapping screws for front installation, screw aperture 4.5mm.  
Sides spacing: 92mm(horizontal), 92mm(vertically), 130mm (diagonal line).



## RV BUILT-IN POWER OUTLET

### KDAQ-16B

3C/CE certifications

- High performance engineering plastic housing, with good corrosion resistance.
- Applicable to 250V/16A, 5V/2100mA.
- Dimensions (W x H x D): 115x136x15mm.
- Color: White, black.
- Opening size for installation: Rectangle opening 90x105mm.
- Protection Class: IP44.
- 4 x ST4.2\*25 countersunk head self tapping screws for front installation, screw aperture 4.5mm.  
Sides spacing: 92mm(horizontal), 92mm(vertically), 130mm (diagonal line).



## RV BUILT-IN CITY WATER INLET

### KDAS-Y01

#### Food Grade

- High performance engineering plastic housing, with good corrosion resistance and food grade.
- Dimensions (W x H x D): 115x136x15mm.
- Color: White, black.
- Installation aperture: Ø 96mm.
- Protection Class: IP44.
- 4 x ST4.2\*25 countersunk head self tapping screws for front installation, screw aperture 4.5mm.  
Sides spacing: 92mm(horizontal), 92mm(vertically), 130mm (diagonal line).



## RV MULTI PURPOSE INLET

### KDAW-01

#### 3C/CE certifications

- High performance engineering plastic housing, with good corrosion resistance.
- Dimensions (W x H x D): 115x136x15mm.
- Color: White, black.
- Opening size for installation: Rectangle opening 90x105mm.
- Protection Class: IP44.
- 4 x ST4.2\*25 countersunk head self tapping screws for front installation, screw aperture 4.5mm.  
Sides spacing: 92mm(horizontal), 92mm(vertically), 130mm (diagonal line).





**ARANA LIVING TECHNOLOGY (SHANDONG) CO., LTD.**

Room 2306, Building #2, Silver Crystal Plaza, No. 66 East Shunhe Road  
Shizhong District, Jinan City, Shandong Province, China 250012  
+86 531 8889 4655 · 400 110 1890 · [www.arana.com.cn](http://www.arana.com.cn)

